

KINTEK



SPECIAL TOOLHOLDERS



SONDER-WERKZEUGHALTER



СПЕЦИАЛЬНЫЕ РЕЗЦЕДЕРЖАТЕЛИ



PORTEOUTILS SPECIAUX



PORTAUTENSILI SPECIALI



专用刀柄

NAKAMURA TOME TOOLHOLDERS



NAKAMURA TOME

TW10

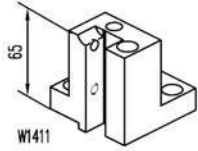

W1411

Face and O.D. cutting holder

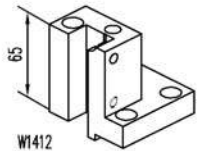

W1412

Face and O.D. cutting holder

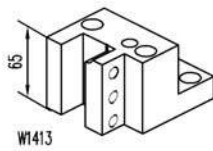

W1413

Face and O.D. cutting holder

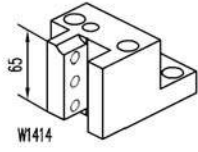

W1414

Face and O.D. cutting holder

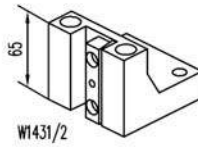

W1431/2

Face and O.D. cutting holder

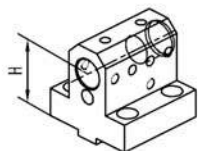

W1417 D25 (H=55 mm)
W4437 D25 (H=75 mm)

Combi toolholder for boring bar and insertdrill

Ø25 mm

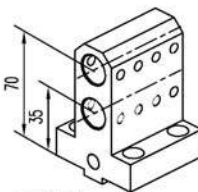

W1418 D25

Double toolholder for boring bar

Ø25 mm

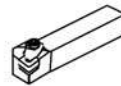

Qualified tool
20x20 mm

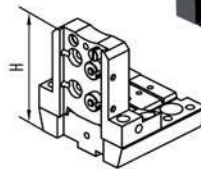

121-22076 (h=32 mm H=100 mm)



Cut-off holder



Cut-off tool

CONNECTION

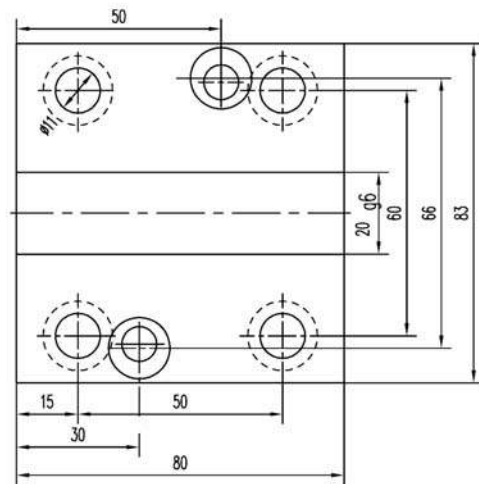

NAKAMURA TOME

WT100

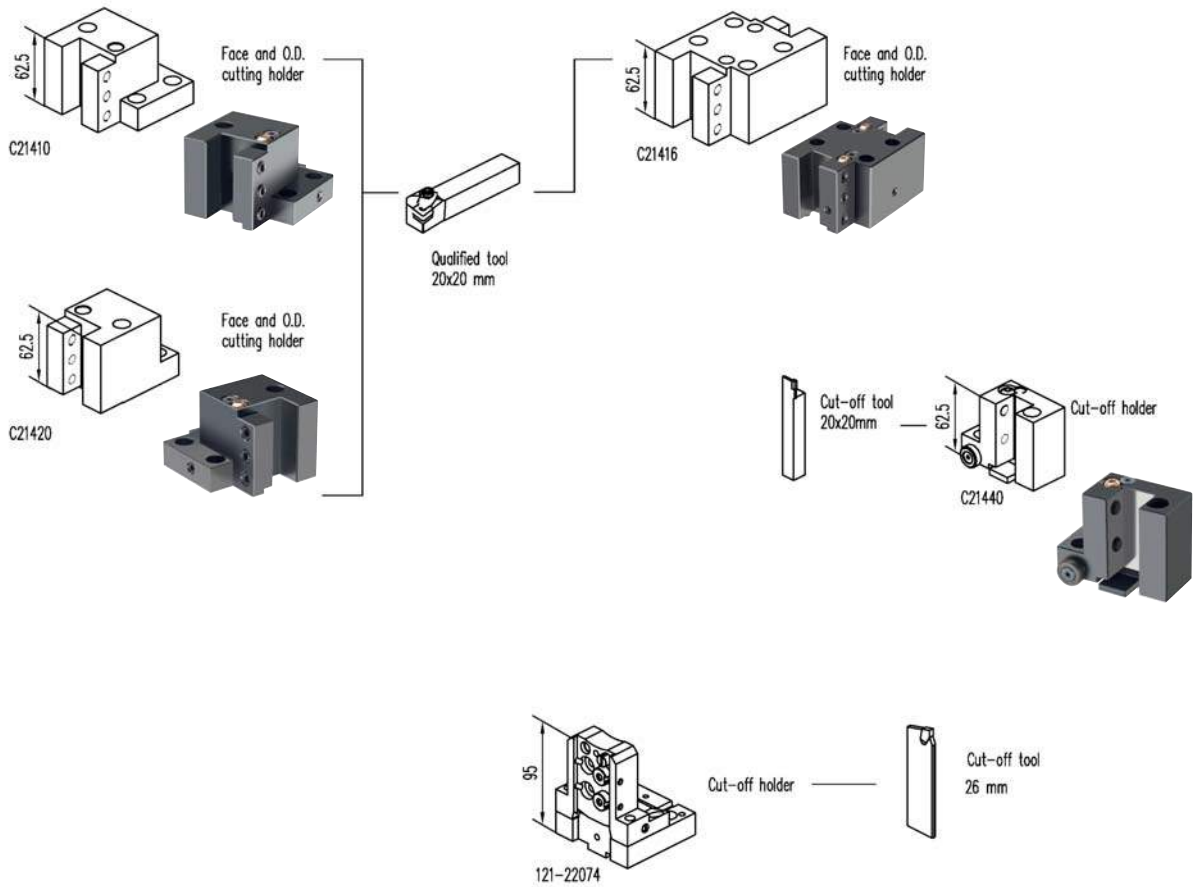

CONNECTION

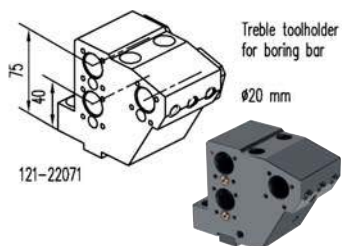
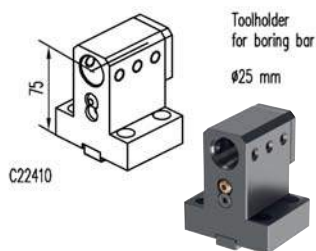
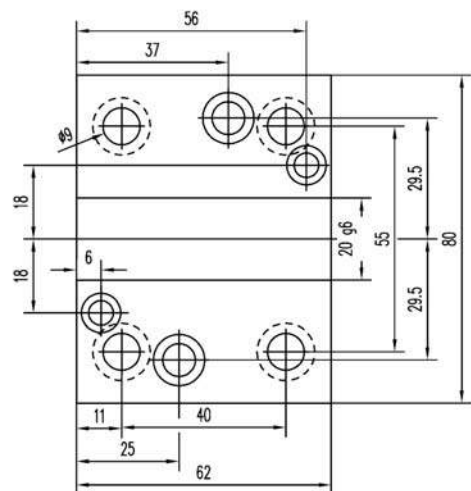

NAKAMURA TOME

WT150 - WTW150 - WTS150
WT250 - SC150 - SC250

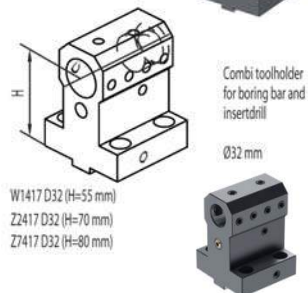
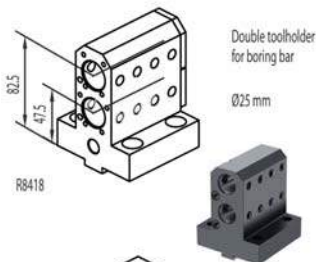
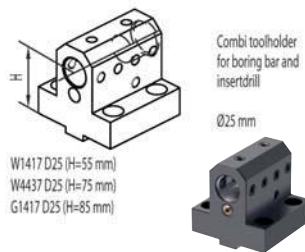
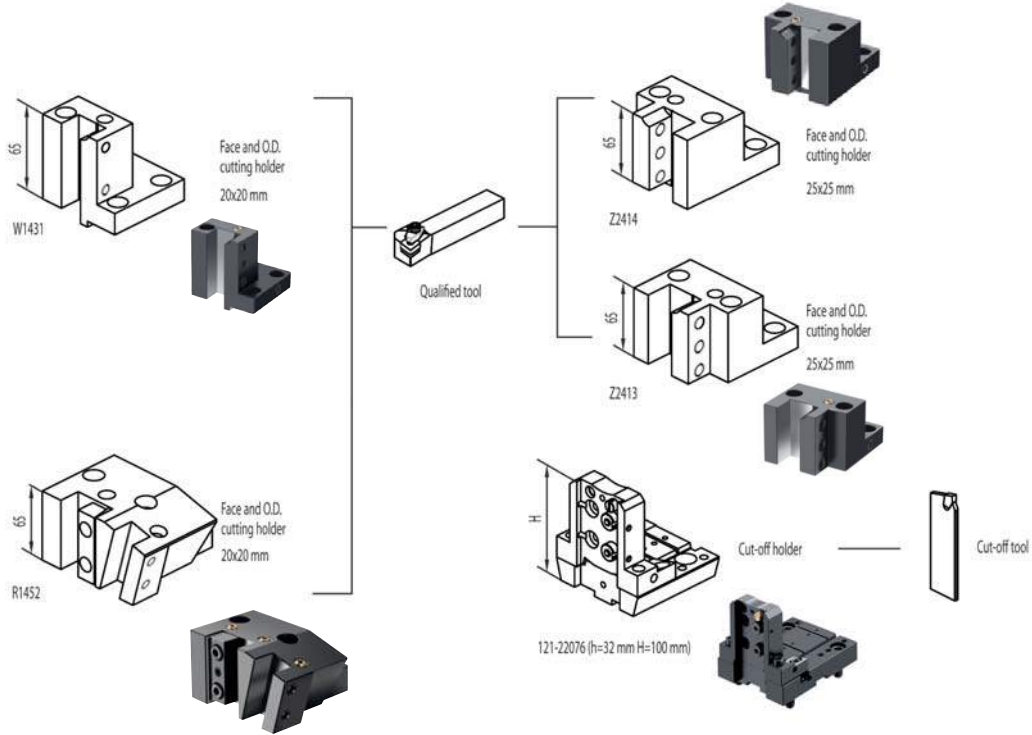

CONNECTION

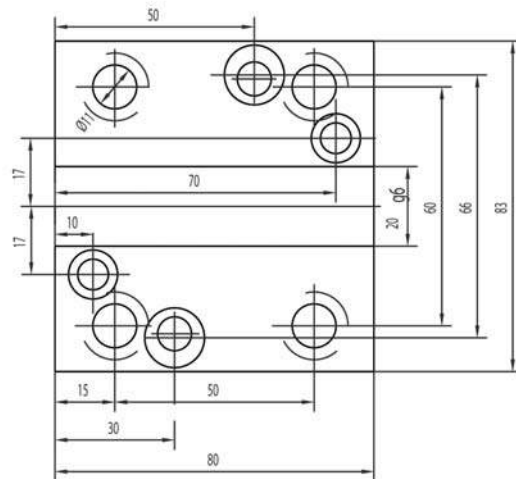



HEAD OFFICE

KINTEK S.R.L. - MAPPANO - TORINO - ITALY



NEW PRODUCTION PLANT

A.M.T S.R.L. - CASELLE T.SE - TORINO - ITALY



MAIN PRODUCTION PLANT

KINTEK TOOLING KFT - BEKESCSABA - HUNGARY

KINTEK

VIA GORETTA 88/G - 10072 MAPPANO
FRAZIONE DI CASELLE (TO) - ITALIA
Tel. +39.011.9968065 - Fax +39.011.9965662
<http://www.kintek.it> - e-mail:info@kintek.it